

**Features**

- Low  $R_{DS(ON)}$ :
  - 75 m $\Omega$  @  $V_{GS} = -4.5V$
  - 110 m $\Omega$  @  $V_{GS} = -2.7V$
  - 125 m $\Omega$  @  $V_{GS} = -2.5V$
- Low Input/Output Leakage
- **Lead, Halogen and Antimony Free, RoHS Compliant "Green" Device (Notes 3, 4 and 5)**
- **Qualified to AEC-Q101 Standards for High Reliability**

**Mechanical Data**

- Case: SOT-23
- Case Material - Molded Plastic, "Green" Molding Compound. UL Flammability Rating 94V-0
- Moisture Sensitivity: Level 1 per J-STD-020D
- Terminals: Finish - Matte Tin annealed over Copper leadframe. Solderable per MIL-STD-202, Method 208
- Terminal Connections: See Diagram Below
- Marking Information: See Page 4
- Ordering Information: See page 4
- Weight: 0.008 grams (approximate)



TOP VIEW

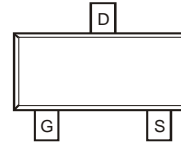
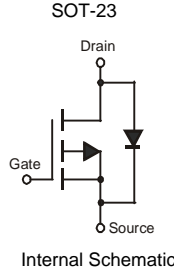

TOP VIEW

**Maximum Ratings** @  $T_A = 25^\circ C$  unless otherwise specified

Characteristic	Symbol	Value	Unit
Drain-Source Voltage	$V_{DSS}$	-20	V
Gate-Source Voltage	$V_{GSS}$	$\pm 12$	V
Drain Current (Note 1) Continuous	$I_D$	-3.0 -2.4	A
		$T_A = 25^\circ C$ $T_A = 70^\circ C$	
Pulsed Drain Current (Note 2)	$I_{DM}$	-15	A
Body-Diode Continuous Current (Note 1)	$I_S$	2.0	A

**Thermal Characteristics**

Characteristic	Symbol	Value	Unit
Total Power Dissipation (Note 1)	$P_D$	1.4	W
Thermal Resistance, Junction to Ambient (Note 1); Steady-State	$R_{\theta JA}$	90	$^\circ C/W$
Operating and Storage Temperature Range	$T_J, T_{STG}$	-55 to +150	$^\circ C$

- Notes:
1. Device mounted on 1"x1", FR-4 PC board with 2 oz. Copper and test pulse width  $t \leq 10s$ .
  2. Repetitive Rating, pulse width limited by junction temperature.
  3. No purposefully added lead. Halogen and Antimony Free.
  4. Diodes Inc's "Green" policy can be found on our website at [http://www.diodes.com/products/lead\\_free/index.php](http://www.diodes.com/products/lead_free/index.php).
  5. Product manufactured with Green Molding Compound and does not contain Halogens or  $Sb_2O_3$  Fire Retardants.

**Electrical Characteristics** @ $T_A = 25^\circ\text{C}$  unless otherwise specified

Characteristic	Symbol	Min	Typ	Max	Unit	Test Condition
<b>STATIC PARAMETERS</b>						
Drain-Source Breakdown Voltage	$BV_{DSS}$	-20	—	—	V	$I_D = -250\mu\text{A}, V_{GS} = 0\text{V}$
Zero Gate Voltage Drain Current	$I_{DSS}$	—	—	-1	$\mu\text{A}$	$V_{DS} = -20\text{V}, V_{GS} = 0\text{V}$
Gate-Body Leakage Current	$I_{GSS}$	—	—	$\pm 100$	nA	$V_{DS} = 0\text{V}, V_{GS} = \pm 12\text{V}$
Gate Threshold Voltage	$V_{GS(th)}$	-0.6	—	-1.25	V	$V_{DS} = V_{GS}, I_D = -250\mu\text{A}$
On State Drain Current (Note 6)	$I_D(ON)$	-15	—	—	A	$V_{GS} = -4.5\text{V}, V_{DS} = -5\text{V}$
Static Drain-Source On-Resistance (Note 6)	$R_{DS(ON)}$	—	51 87 99	75 110 125	$\text{m}\Omega$	$V_{GS} = -4.5\text{V}, I_D = -3.5\text{A}$ $V_{GS} = -2.7\text{V}, I_D = -3.0\text{A}$ $V_{GS} = -2.5\text{V}, I_D = -2.6\text{A}$
Forward Transconductance (Note 6)	$g_{FS}$	—	7.3	—	S	$V_{DS} = -10\text{V}, I_D = -3.0\text{A}$
Diode Forward Voltage (Note 6)	$V_{SD}$	—	0.79	-1.26	V	$I_S = -1.7\text{A}, V_{GS} = 0\text{V}$
Maximum Body-Diode Continuous Current (Note 1)	$I_S$	—	—	1.7	A	—
<b>DYNAMIC PARAMETERS (Note 7)</b>						
Total Gate Charge	$Q_g$	—	7.3	—	nC	$V_{GS} = -4.5\text{V}, V_{DS} = -10\text{V}, I_D = -3.0\text{A}$
Gate-Source Charge	$Q_{gs}$	—	2.0	—	nC	$V_{GS} = -4.5\text{V}, V_{DS} = -10\text{V}, I_D = -3.0\text{A}$
Gate-Drain Charge	$Q_{gd}$	—	1.9	—	nC	$V_{GS} = -4.5\text{V}, V_{DS} = -10\text{V}, I_D = -3.0\text{A}$
Turn-On Delay Time	$t_{D(on)}$	—	12	—	ns	$V_{DS} = -10\text{V}, V_{GS} = -4.5\text{V},$ $R_L = 10\Omega, R_G = 6\Omega$
Turn-On Rise Time	$t_r$	—	20	—	ns	
Turn-Off Delay Time	$t_{D(off)}$	—	38	—	ns	
Turn-Off Fall Time	$t_f$	—	41	—	ns	
Input Capacitance	$C_{iss}$	—	443	—	pF	$V_{DS} = -16\text{V}, V_{GS} = 0\text{V}$ $f = 1.0\text{MHz}$
Output Capacitance	$C_{oss}$	—	128	—	pF	
Reverse Transfer Capacitance	$C_{rss}$	—	101	—	pF	

Notes: 6. Test pulse width  $t = 300\mu\text{s}$ .  
7. Guaranteed by design. Not subject to production testing.

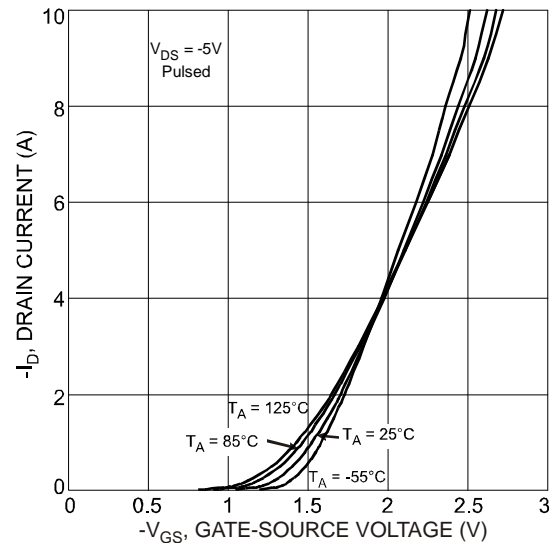
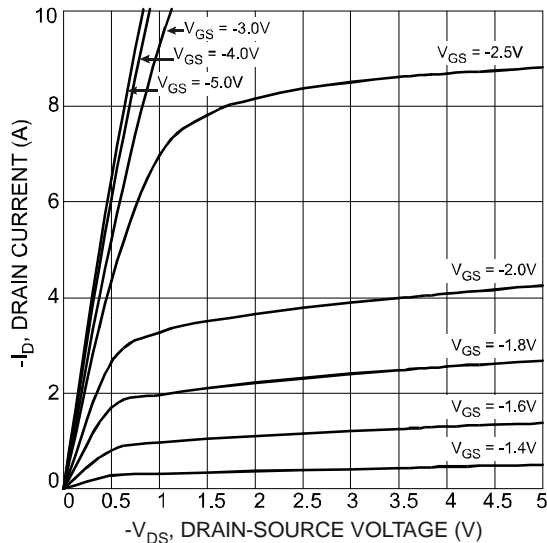

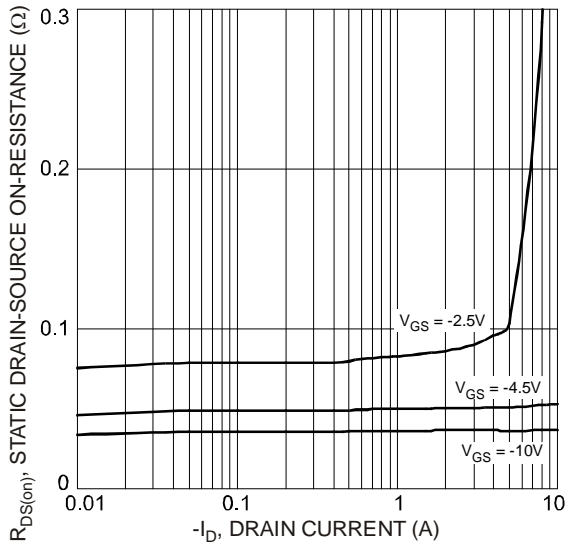

Fig. 3 On-Resistance vs. Drain Current and Gate Voltage

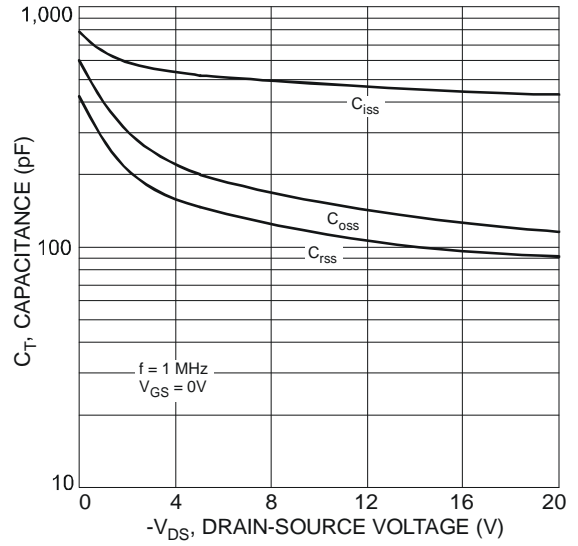

Fig. 4 Typical Total Capacitance

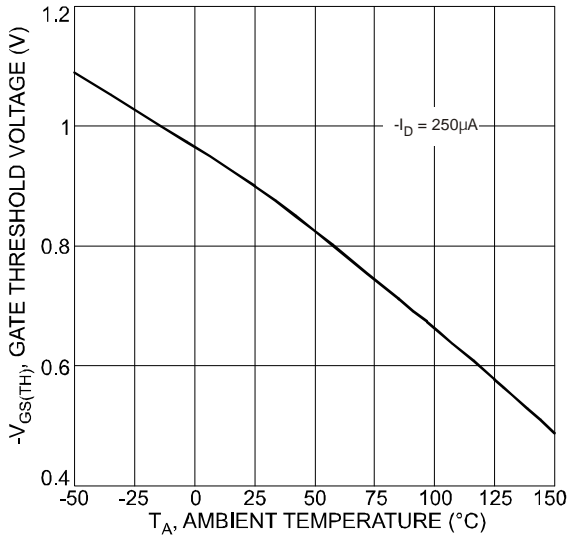

Fig. 5 Gate Threshold Voltage vs. Ambient Temperature

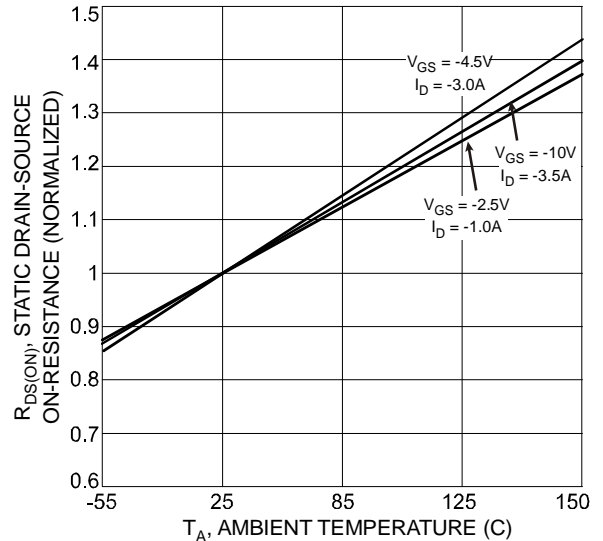

Fig. 6 Normalized Static Drain-Source On-Resistance vs. Ambient Temperature

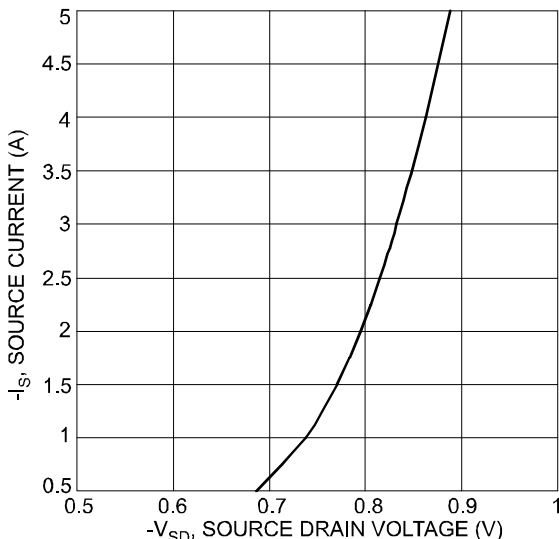

Fig. 7 Reverse Drain Current vs. Source-Drain Voltage

**Ordering Information** (Note 8)

Part Number	Case	Packaging
DMP2130L-7	SOT-23	3000/Tape & Reel

Notes: 8. For packaging details, go to our website at <http://www.diodes.com/datasheets/ap02007.pdf>.

**Marking Information**

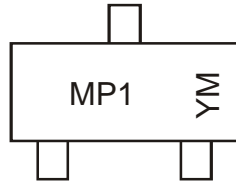

MP1 = Product Type Marking Code  
 YM = Date Code Marking  
 Y = Year ex: U = 2007  
 M = Month ex: 9 = September

Date Code Key

Year	2007	2008	2009	2010	2011	2012
Code	U	V	W	X	Y	Z

Month	Jan	Feb	Mar	Apr	May	Jun	Jul	Aug	Sep	Oct	Nov	Dec
Code	1	2	3	4	5	6	7	8	9	O	N	D

**Package Outline Dimensions**

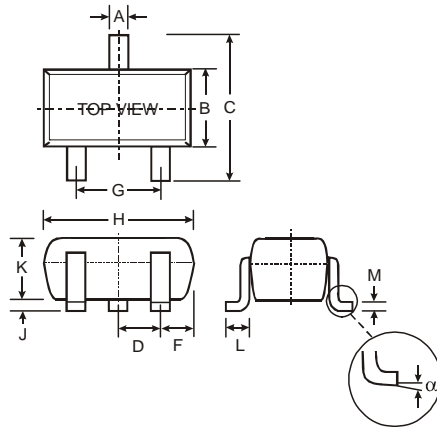

SOT-23		
Dim	Min	Max
A	0.37	0.51
B	1.20	1.40
C	2.30	2.50
D	0.89	1.03
F	0.45	0.60
G	1.78	2.05
H	2.80	3.00
J	0.013	0.10
K	0.903	1.10
L	0.45	0.61
M	0.085	0.180
$\alpha$	0°	8°

All Dimensions in mm

**Suggested Pad Layout**

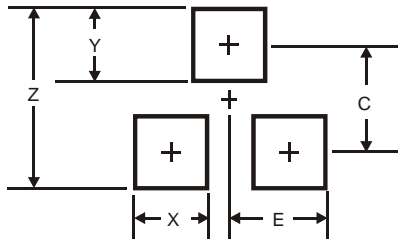

Dimensions	Value (in mm)
Z	2.9
X	0.8
Y	0.9
C	2.0
E	1.35

**IMPORTANT NOTICE**

Diodes Incorporated and its subsidiaries reserve the right to make modifications, enhancements, improvements, corrections or other changes without further notice to any product herein. Diodes Incorporated does not assume any liability arising out of the application or use of any product described herein; neither does it convey any license under its patent rights, nor the rights of others. The user of products in such applications shall assume all risks of such use and will agree to hold Diodes Incorporated and all the companies whose products are represented on our website, harmless against all damages.

**LIFE SUPPORT**

Diodes Incorporated products are not authorized for use as critical components in life support devices or systems without the expressed written approval of the President of Diodes Incorporated.